



European IP Helpdesk

Stay ahead of the innovation game.

Finding Patents

European IP Helpdesk 05.06.2026





European IP Helpdesk

- Service initiative of the European Commission
- Addressing **current and potential beneficiaries of EU-funded projects, researchers and EU SMEs**
- Free-of-charge first-line support on intellectual property (IP)
- Hands-on IP and innovation management support
- International pool of IP experts from various thematic fields
- Unique cooperation scheme with the Enterprise Europe Network: 43 ambassadors from 26 EU countries





The EC IP Helpdesks





EC IP (SME) Helpdesk Hub – Gateway to Information

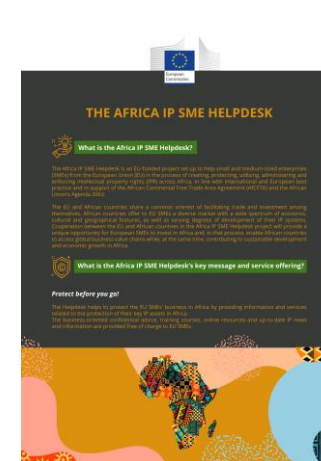
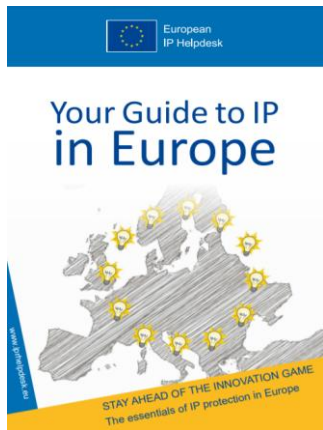

- E-learning modules & more
- Guides / Topic, country, sector-specific factsheets / Infographics
- Case studies



Ambassador Scheme

- **Cooperation scheme** with the Enterprise Europe Network (EEN): 43 ambassadors – 26 countries
- **Building IP capacities** among European SMEs
- **Overcoming language barriers**
- Making the topic **more accessible**
- Exchange and feedback from ambassadors on **needs of SMEs**
- Local **awareness** and **training events**

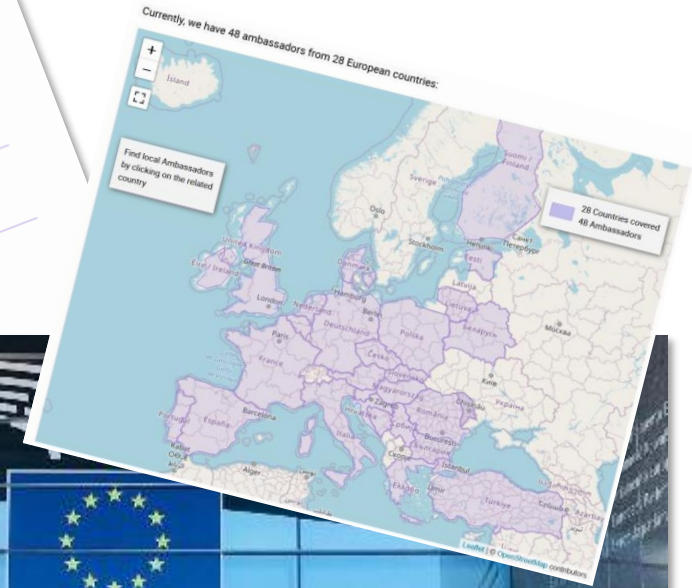
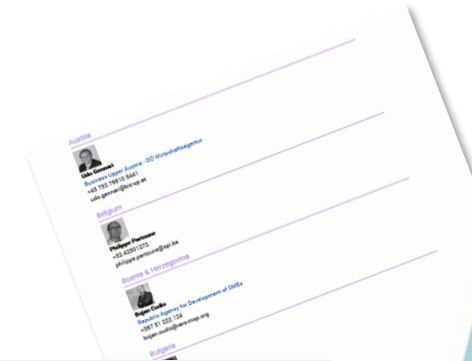



Upcoming events



25
MAY
2026

Training and workshops
[EU - Webinar : Unitary Patent](#)

🔗 Live streaming available

05
JUN
2026

Training and workshops
[EU - Webinar: Finding Patents](#)

🔗 Live streaming available

17
JUN
2026

Training and workshops
[EU - Webinar: Maximizing the Impact of Horizon project results](#)

🔗 Live streaming available

23
JUN
2026

Training and workshops
[EU - Webinar AI Act](#)

🔗 Live streaming available

28
MAY
2026

Training and workshops
[EU - Webinar: Patents and Trade Secrets](#)

🔗 Live streaming available

09
JUN
2026

Training and workshops
[EU - Webinar: Addressing IP impact and innovation in EU projects](#)

🔗 Live streaming available

18
JUN
2026

Training and workshops
[EPO Training Coop: From Lab to Market - Building Strategic Options with IP](#)

📍 Online only

🔗 Live streaming available

24
JUN
2026

Training and workshops
[Protect your IP in health technology: Focus on robotics and health appliances](#)

🔗 Live streaming available



Thank you!

- www.ec.europa.eu/ip-helpdesk
- helpline@iprhelphdesk.eu
- training@iprhelphdesk.eu
- Twitter [@iprhelphdesk](https://twitter.com/iprhelphdesk)
- LinkedIn [/european-ipr-helpdesk](https://www.linkedin.com/company/european-ipr-helpdesk)





About me

BSc (Physical) Chemistry (*Exon UK*)

PhD Neutron Science (*Exon UK*)

Harwell (UK), Rutherford Appleton (UK), ILL Grenoble (FR)

Royal Society of Chemistry, Institute of Physics,
Science Council (UK)

HM Govt, X-ray, electron, laser beam microanalysis

Looooooooooooooooong time at European Patent Office (NL, AT)

Patent examiner (electron and ion optics) IT manager, internet
services Espacenet et al, manager, research manager

Consultant; bring worlds of STEM and IP together IPHelpdesk,
EPO, EUIPO, WIPO

Cambridge University Technology Management teaching and
research (*Cantab UK*)





Finding Patents

Independent of:

Search tool

Database

AI

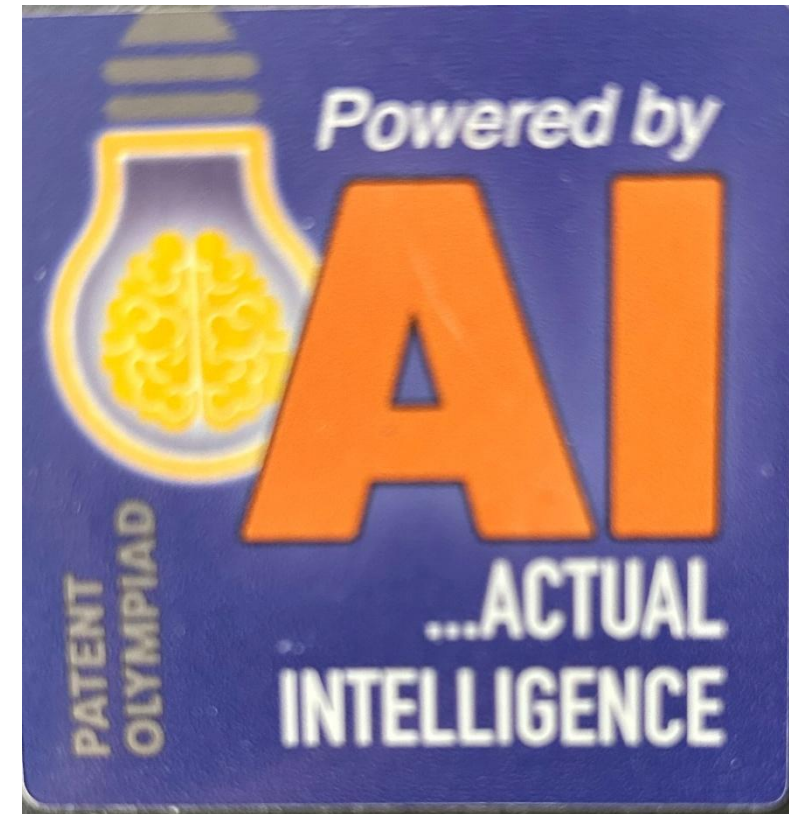



Nigel S. Clarke, The basics of patent searching, World Patent Information, Volume 54, Supplement, 2018, Pages S4-S10, ISSN 0172-2190,



The basics of patent searching

Nigel S. Clarke

European Patent Office, Austria 86, 1933 Vienna, Austria

ARTICLE INFO

Article history:
Received 24 September 2018
Revised to final form
10 January 2019
Accepted 27 February 2019

Keywords:
Patents
Searching
Basis
Mind set
Concepts

ABSTRACT

Basic aspects of patent searching are similar to searching other kinds of technical literature, such as articles in popular science magazines or papers in professional and academic journals. However some aspects of searching patents are sufficiently different from searching conventional literature, that a dedicated combinator, strategy and tactics need to be applied to the task. The difference between searching conventional publications and patents arise, amongst other things, from the nature of the patent documents themselves, the interrelation between them and the unique way in which patent databases are constructed. This article describes an approach, and search techniques for searching patents, which will enable the absolute beginner to make a start, and gain confidence in searching patent literature.

© 2019 The Author. Published by Elsevier Ltd. This is an open access article under the CC BY-NC-ND license (<http://creativecommons.org/licenses/by-nc-nd/4.0/>)

1. Introduction

This article is based on a presentation delivered by the author at the Search Matters Seminar held at the European Patent Office (EPO) in The Hague in June 2018. The presentation was commissioned by the Search Matters organisers especially to cater for those participants who were curious to know more about patent searching. This article covers some useful basic concepts in patent searching and some ‘tips and tricks’ which hopefully the absolute beginner might find helpful. The article also incorporates ideas presented by the author over many years, in the ‘European Patent Information Register’ seminar series and in introductory webinars [1,2].

The article is also about the psychology of patent searching, the mind-set, concepts, strategies and tactics, and is deliberately intended to be a general introduction only. It is not intended to promote any particular search tools or databases. However, by way of example only, search results and techniques in this article are illustrated by use of EPO tools and databases.

2. The 64,000 dollar question: why search patents?

The trivial answer to this question is: ‘because they are there’ [3]. However there are many genuine and justifiable reasons for searching patents [4]: to find out about the most recent invention, to study the development of a particular technology, or to find the

patent by an eminent academic, for example. The publication of patent documents, which necessarily contain a full technical description of the invention, is a mandatory step in the patent process. Patent offices around the world are required by convention to publish the patents registered with them. A patent cannot be a patent unless it is published [5].

Most patent offices publish patent applications before any other publications. The existing volume of patent documents is huge. Publicly available free patent databases, for example Espacenet, Patentscope and DepatBler [6] give access to tens of millions of patent documents. The cumulative volume of patent documents is growing rapidly too: 2.9 million patent applications are reported as having been filed in 2015 worldwide [7]. The patent process requires that all of these be published. Despite the volume and rapid growth in publications, searching patents is assisted by indexing or classification schemes which allow you to focus your search direction early on. Patents not only contain technical information about inventions, patents are legal instruments and confer rights and privileges on their owners. So it may be that you would want to identify and characterise the legal status of particular patents. The patent documents also contain contact information about the applicants, the people or organisations who filed the patent application in the first place. Patents also list inventors, the clever individuals who had the ideas, and did the work in laboratories or factories or workshops. Inventors and applicants can be identified by searching patents, and this information can be commercially important.

Email address: nclarke@epo.org



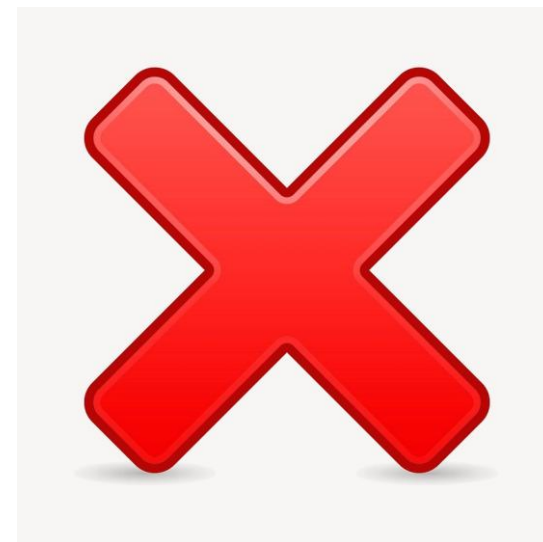



- Finding – not just searching



<https://i.ytimg.com/vi/qLQJdK1Lmi0/maxresdefault.jpg>



Finding Patents

- [1. Introduction](#)
- [2. The 64,000 dollar question: why search patents?](#)
- [3. Before you begin](#)
- [4. Types of patent search](#)
- [5. Keywords or.....?](#)
- [6. Why shouldn't I search in patent titles only?](#)
- [7. Cut to the chase – patent classifications](#)
- [8. What's in a name?](#)
- [9. The same, but different – patent families](#)
- [10. As close, as close as can be – citations](#)
- [11. Alive or dead? Legal status](#)
- [12. Keep your finger on the pulse – alerting and monitoring](#)
- [13. Patent search resources](#)



Introduction

- Background
 - EPO Patent Information Beginners Courses
 - EPO Search Matters Seminars
- Concepts
 - Mindset, strategies, tactics, tips and tricks



Introduction

- How did you get here?
- What is your company's interest?
- Why are you searching?
- Who sees your search results?
- What information are you looking for?



64,000 dollar question – why search patents?





64,000 dollar question – why search patents?

- Huge resource
 - >100,000,000 patent documents
 - 3,700,000 filings in 2024 (WIPO)
 - +4.9%(WIPO)
 - <https://www.wipo.int/en/ipfactsandfigures/patents>



64,000 dollar question – why search patents?

- Unique content
 - technical
 - legal
 - commercial
- Curated



Types of patent search

- State of the art – finding what 's out there
- Prior art/novelty – patent filing
- Opposition – against someone else 's grant
- Invalidity – against someone else 's existing patent
- Freedom to operate – can I use my invention?



Freedom to operate FTO

Time

When

Place

Where

Technology

What

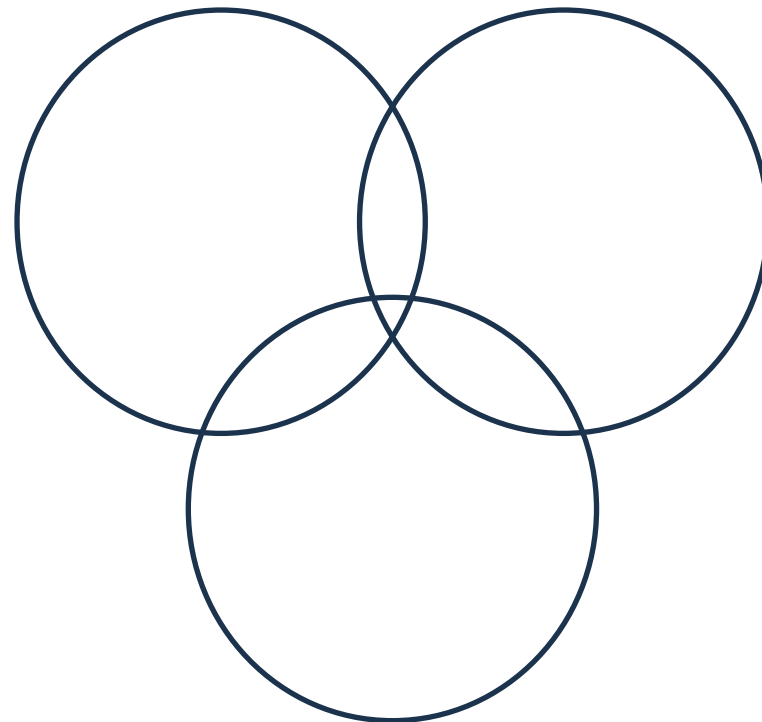



Before you begin

- Read around
- Use other sources
- Find examples

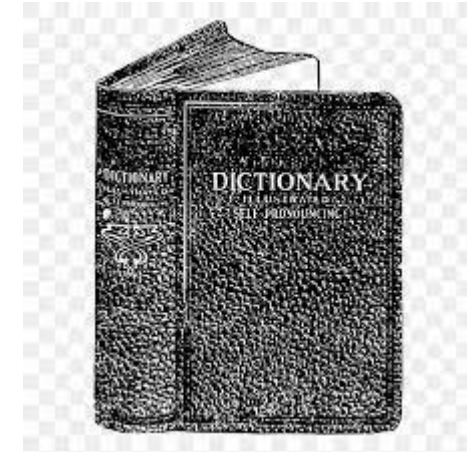
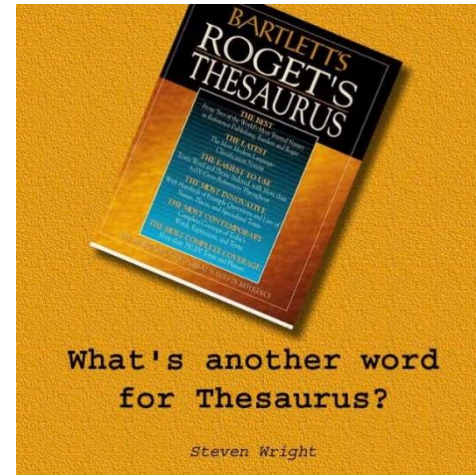



Before you begin

- Recycle food packaging
- Read around:
 - Composite
 - Laminated
 - Aseptic





Before you begin

- Example company
 - “TetraPak”
 - Patents
 - classifications





Keywords or.....?

- Context

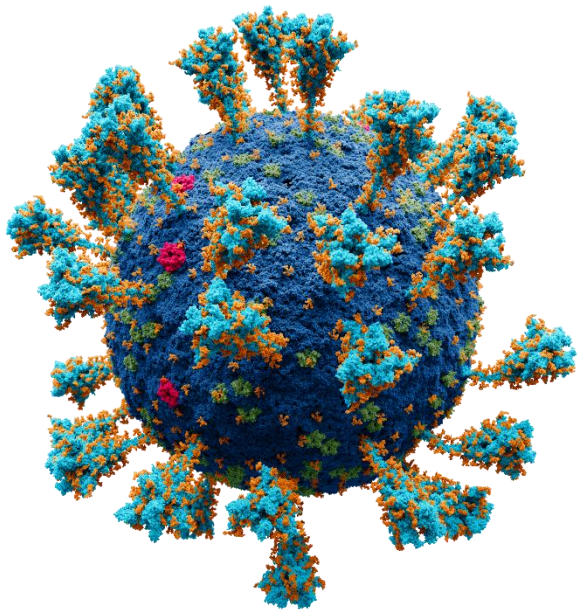



Keywords or.....?

- Context

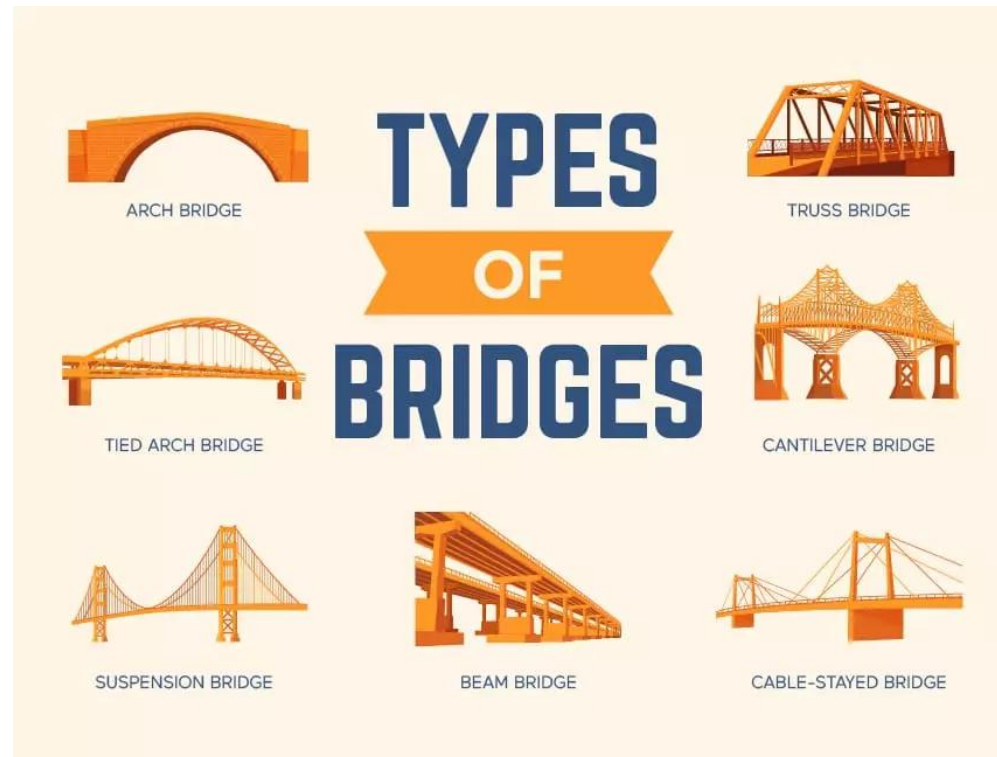

<https://www.bigrentz.com/blog/types-of-bridges>



Keywords or.....?

- Context





Keywords or.....?

- Context





Keywords or.....?

- Context

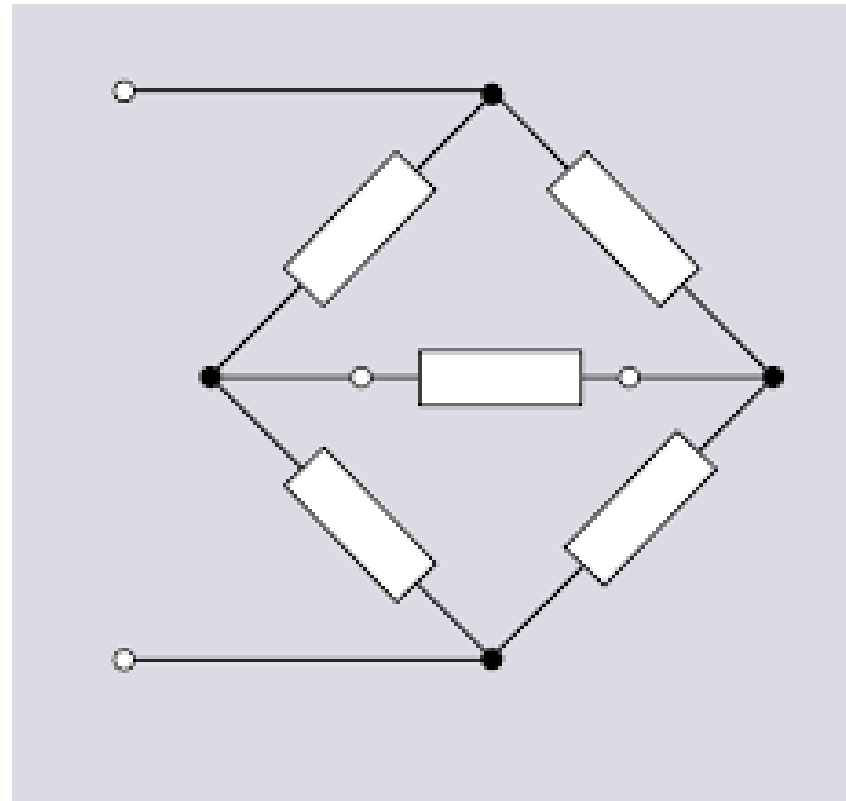



Keywords or.....?

- Context

HOW THE BLOCKCHAIN WORKS

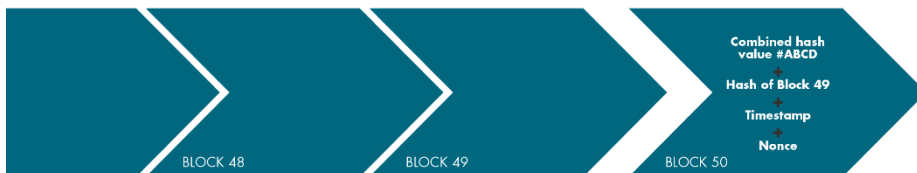
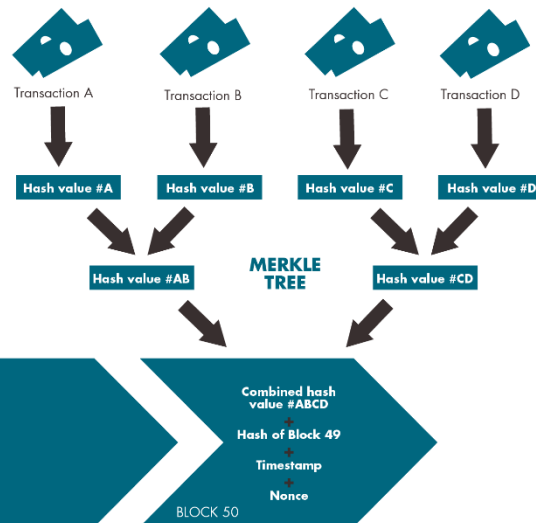
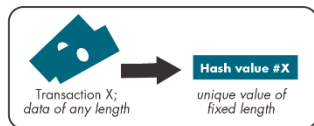



Keywords or.....?

- Synonyms
- Acetic acid = ethanoic acid = ethan-1-carboxylic acid
- Dihydrogen monoxide = water
- Hinge = articulation
- Silicon chip = IC = integrated circuit = microchip



Keywords or.....?

- The special language of patents
- Writing instrument
- Oral hygiene device





Keywords or.....?

- The special language of patents
- “plurality” = “more than one”

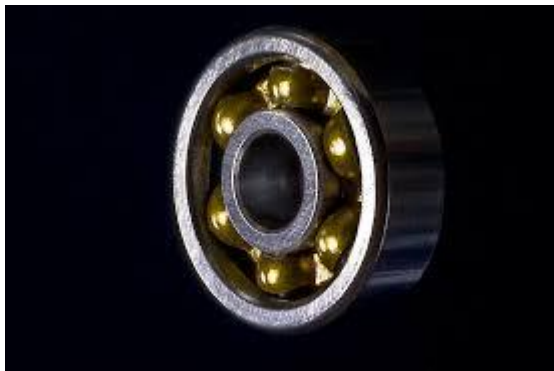



Keywords or.....?

- The special language of patents
- New words “detachably attached”
- “removable”

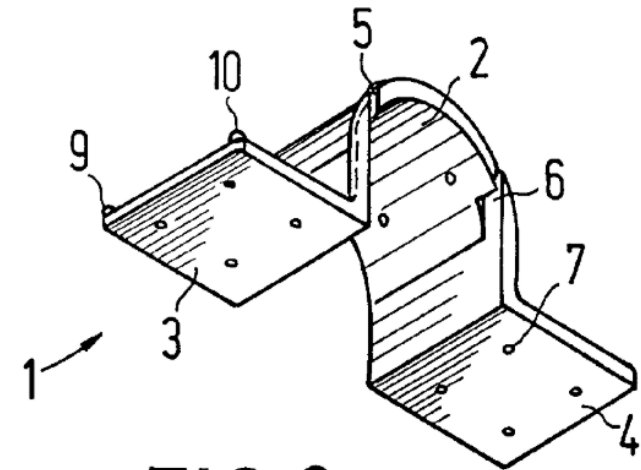
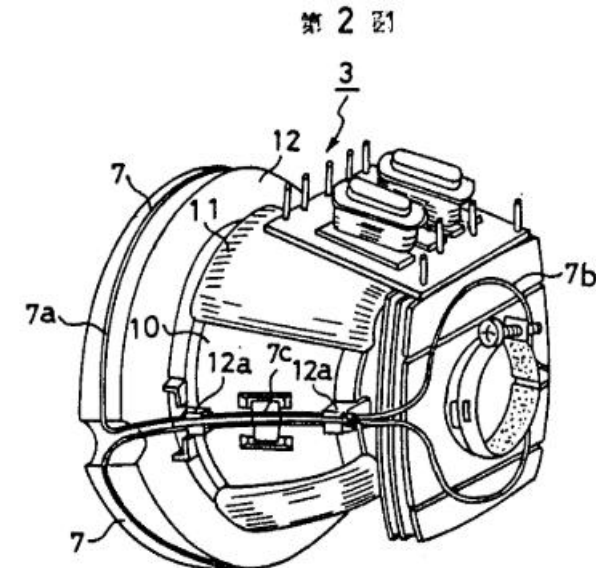
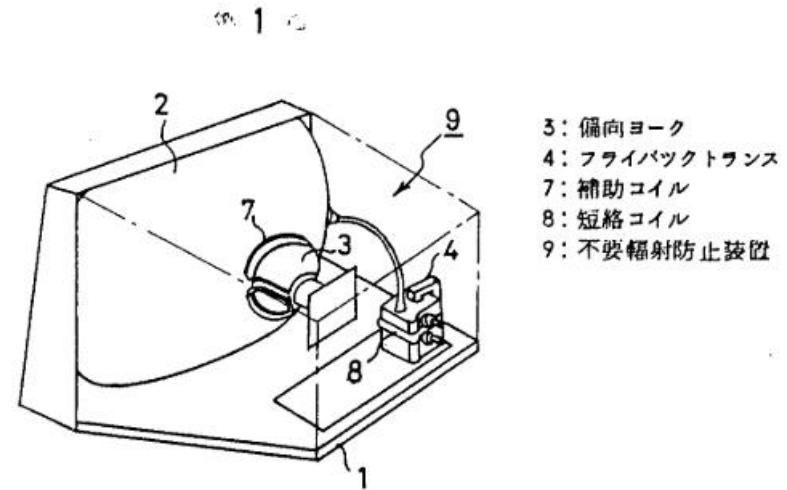

FIG. 3



Keywords or.....?

- Translations
- “Useless radiation preventer”
- “Stray radiation preventer”





Keywords or.....?

- Spellings and mis-spellings
- “Analyse” or “Analyze”
- “Fluorescent” or “Flourescent”
- “Receiver” or “Reciever”



Why shouldn't I search in patent titles only?

- Uninformative
 - “Pharmaceuticals”
 - “Improvements”
 - “Methods” “Process” “Device” “Apparatus”



Why shouldn't I search in patent titles only?

- Ambiguous:
 - “Refrigerator” (one word title 19,000 hits)
 - E.g. EP4361543

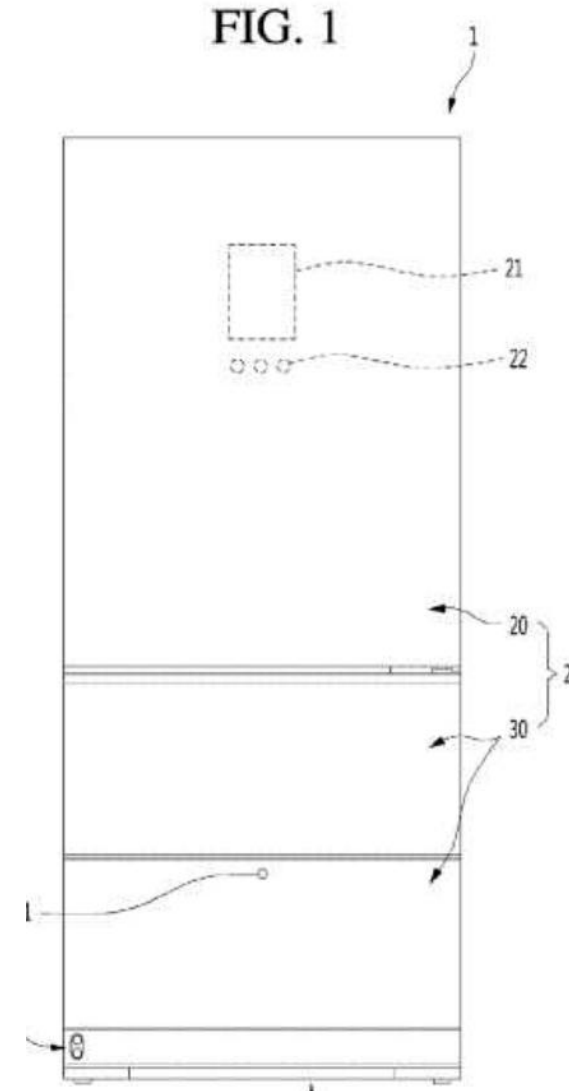



Why shouldn't I search in patent titles only?

- Very (overly) specific
 - “3-(5-NITRO-2-FURYL) 1H PYRAZOLO[3,4] PYRIMIDINS - 4(5H)-ONES

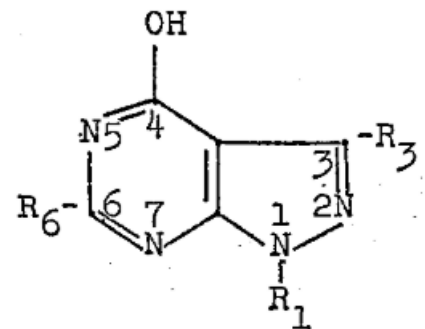



Why shouldn't I search in patent titles only?

- Only if you really really know the title
- “Generally spherical object with Floppy filaments to promote sure capture”





Why shouldn't I search in patent titles only?

- Better to search in abstract

(54) **Apparatus for manufacturing green bricks for the brick manufacturing industry**

(57) The invention relates to an apparatus (1) for manufacturing green bricks from clay for the brick manufacturing industry, comprising a circulating conveyor (3) carrying mould containers combined to mould container parts (4), a reservoir (5) for clay arranged above the mould containers, means for carrying clay out of the reservoir (5) into the mould containers, means (9) for pressing and trimming clay in the mould containers,

means (11) for supplying and placing take-off plates for the green bricks (13) and means for discharging green bricks released from the mould containers, characterized in that the apparatus further comprises means (22) for moving the mould container parts (4) filled with green bricks such that a protruding edge is formed on at least one side of the green bricks.



Why shouldn't I search in patent titles only?

- Even better to search in full text
 - Abstract – summary
 - Description – enabling disclosure
 - Claims – the legal bit



Cut to the chase – patent classifications

- Like a ZIP or Postal Code for patents
- Patents in closely related technologies are classified together
 - (same ZIP or Postal Code)
- Facilitates searching and examination



Cut to the chase – patent classifications

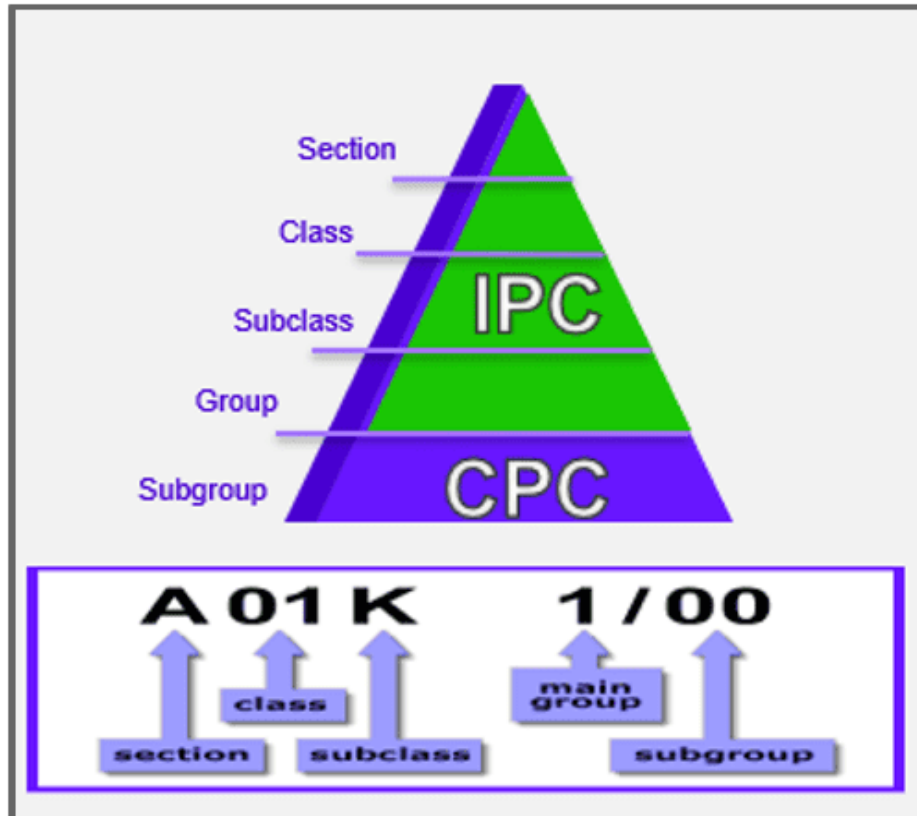

<https://clarivate.com/derwent/learning/resources/derwent-innovation/derwent-research-guides/research-patents-in-a-specific-technology-domain/>



Cut to the chase – patent classifications

Section: The highest level of the code, which represents a broad technology area (e.g., A-Human Necessities)

Class: A major sub-area of the technology (e.g., A01-Agriculture)

Subclass: A specific, broad application for the technology area (e.g., A01K-Animal Husbandry)

Main Group: Major components of technology for a particular application (e.g., A01K 1/00Housing Animals)

Subgroup: Precisely defines a specific field within a main group



Cut to the chase – patent classifications

- Relevant classification plus keywords – very powerful!
- A63C17/12 – Roller skates or skateboards with driving mechanisms - >2500 hits
- Keyword “internal combustion engine”
- Combine – 6 hits

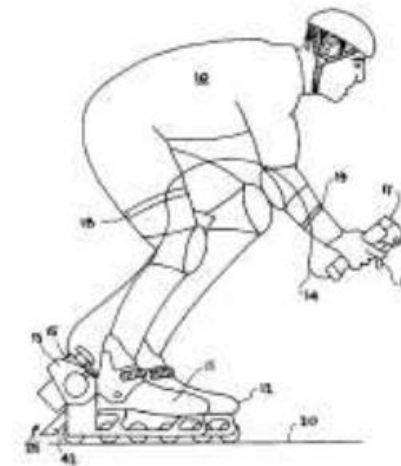



Boolean operators combine search terms

The AND operator restricts the number of hits
The OR operator expands the number of hits
The NOT operator also restricts the number of hits

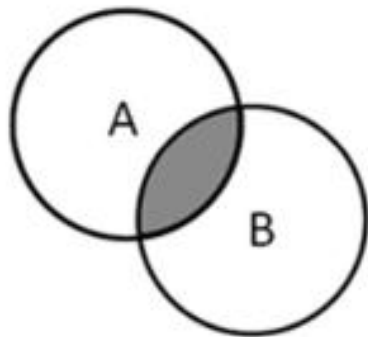

A AND B

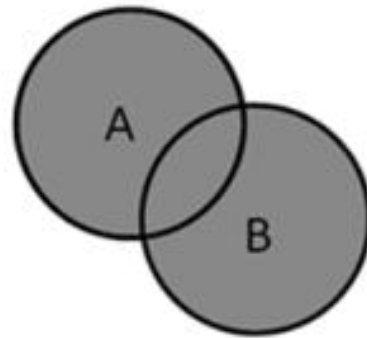

A OR B

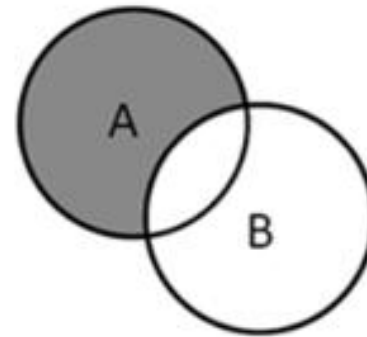

A NOT B



What's in a name?

- Two types of name
- Inventor
- Applicant (patent owner)





What's in a name?

- Applicant (patent owner) name
- Inc. GmbH. Ltd. AG.
- Holding companies
- Filing Companies





What´s in a name?

- Inventor name
- Misspellings: “Clarke” “Clark”
- Variations: “Asterix the Gaul”,
“Gaul, Asterix the”, “A.T Gaul”
- Genuine different spellings
“Clarke” “Clark” “Brown” “Browne”





The same, but different – patent families



FR
IT
DE
ES
GB
US
AU
NZ
JP
CN



The same, but different – patent families

- Same invention
- Filed in different countries
- Within 12 months
- Useful for translations
- Insight into business strategy



As close, as close can be - citations

- Like citations in scientific papers
- Examiner opinion on patentability
 - Novelty - X
 - Inventiveness -Y-Y
 - Usefulness – problem/solution
- Minimum list of most relevant citations



As close, as close can be - citations

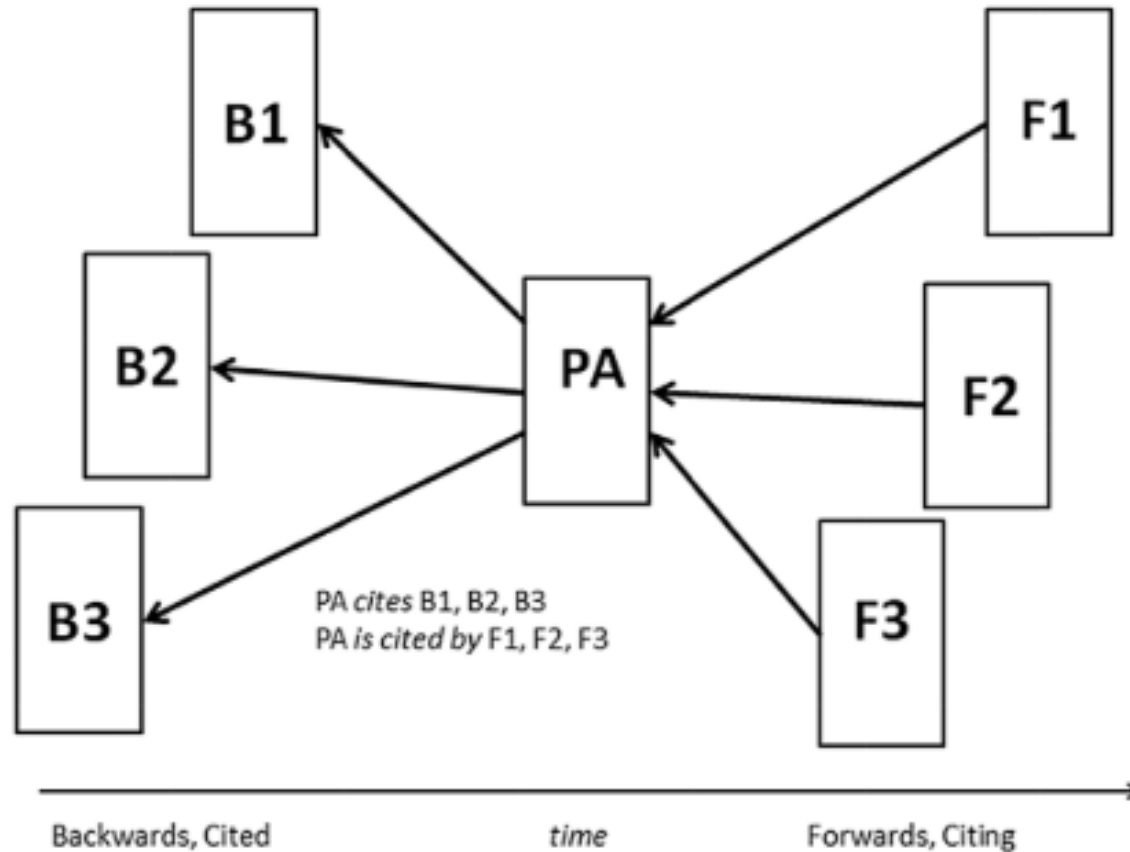

Fig. 1. Forward and backward citations cited and citing documents.



As close, as close can be - citations



World Patent Information
Volume 54, Supplement, September 2018, Pages S23-S28



How to interpret EPO search reports

[Kris Loveniers](#)

Kris Loveniers,
How to interpret EPO
search reports,
World Patent Information,
Volume 54, Supplement,
2018,
Pages S23-S28,
ISSN 0172-2190,



Legal Status Patent granting process

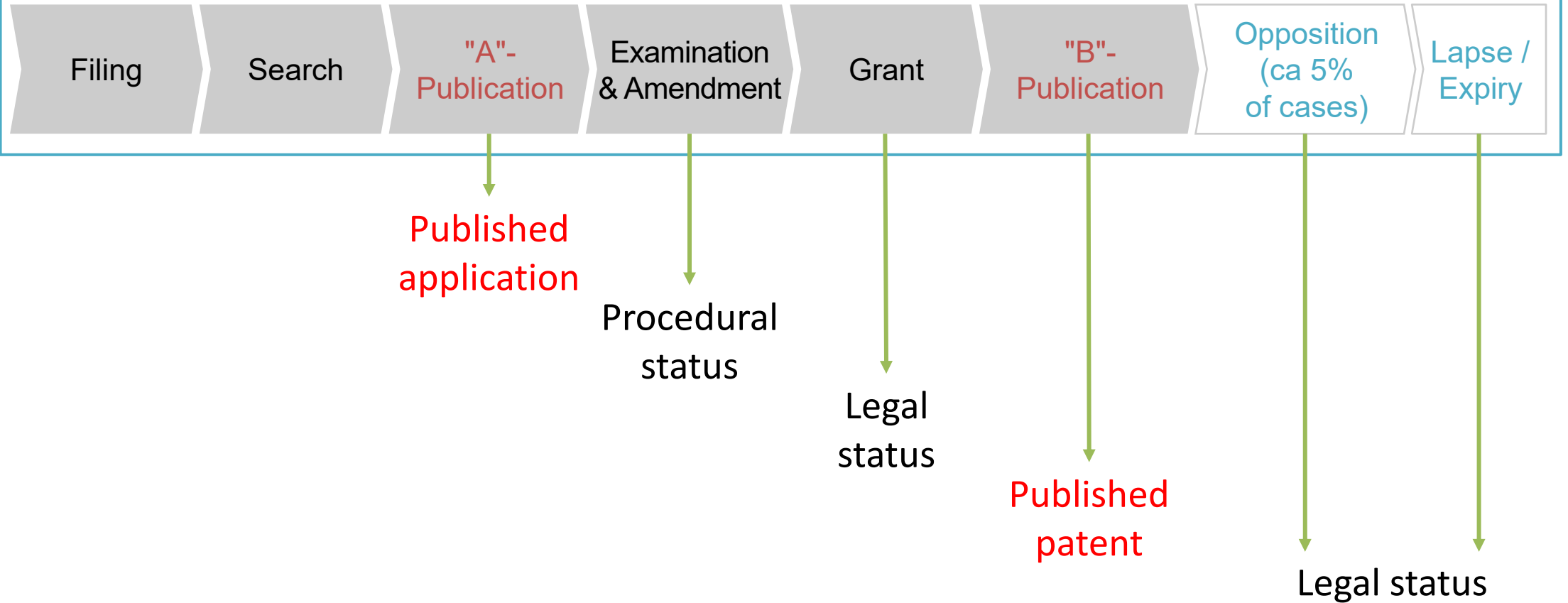



Alive or dead? Legal status

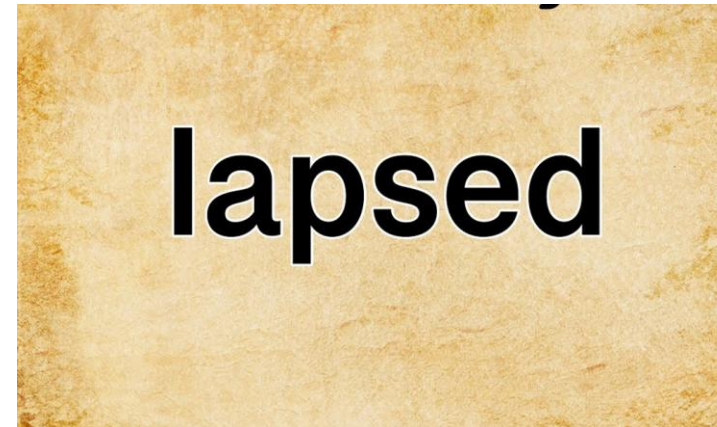



Alive or dead? Legal status

- Federated Register



Europäisches Patentamt
European Patent Office
Office européen des brevets

European Patent Register

Deutsch English Français
Contact

◀ About European Patent Register Other EPO online services ▶ Register Alert (email alerts)

Smart search Advanced search Help

EP3582176
European procedure
EP About this file
EP Legal status
EP Federated register
EP Event history
EP Citations
EP Patent family
EP All documents

EP Federated register: EP3582176

🔍 Refine search ↓ ST36 ↗ Espacenet 📄 Submit observations 🗑️ Report error 🖨️ Print

IMAGE PROCESSING APPARATUS			
Application No.	Publication No.	Applicant	IPC
EP19196620	EP3582176	FotoNation Limited	G06T3/60

Only designated contracting states, extension states and validation states providing the Federated Register Service are listed below.

Quick help

- [What is the Federated Register?](#)
- [Who is it for?](#)
- [What type of information will be displayed?](#)
- [Which countries provide data to the Federated Register service?](#)
- [What statuses are available in the Federated Register?](#)
- [How can I get direct access to national office registers?](#)
- [What data is provided by the national patent offices in the Federated Register?](#)
- [What does "invalidation date" mean?](#)
- [What does "not in force since" mean?](#)
- [What does "record last updated" mean?](#)
- [Why is there a difference](#)

	Status	Application No.	Publication No.	Proprietor	Invalidation date	Not in force since	Renewal fees last paid	Record last updated
↗ AT	Patent not validated	EP19196620	EP3582176	FotoNation Limited	10.02.2021	28.10.2020	---	---
↗ BE	Patent lapsed	EP19196620	EP3582176	FotoNation Limited	---	30.09.2021	---	12.05.2023
↗ BG	<i>No data provided by the national patent office for this patent</i>							
↗ CH/LI	Patent not in force	EP19196620	EP3582176	FotoNation Limited	27.04.2023	27.04.2023	---	27.04.2023
↗ CZ	Patent not validated	CZ2019-196620	EP3582176	FotoNation Limited	10.05.2021	11.09.2019	---	12.05.2021
↗ DE	Patent in force	EP19196620	EP3582176	FotoNation Limited, Galway, IE	---	---	---	06.10.2023
↗ EE	<i>No data provided by the national patent office for this patent</i>							



Global Dossier



Australian Government
IP Australia



Canadian
Intellectual Property
Office

רשות הפטנטים
ISRAEL PATENT OFFICE
سلطة براءات الاختراع





Alive or dead? Legal status

Lapsed or expired



FR
IT
DE
ES
GB
US
AU
NZ
JP
CN



Keep your finger on the pulse – alerting and monitoring

- Alerting – new patent publications appearing
- Monitoring – changes in published patents



Patent search resources





stanfieldclarke@gmail.com

